

fasad A

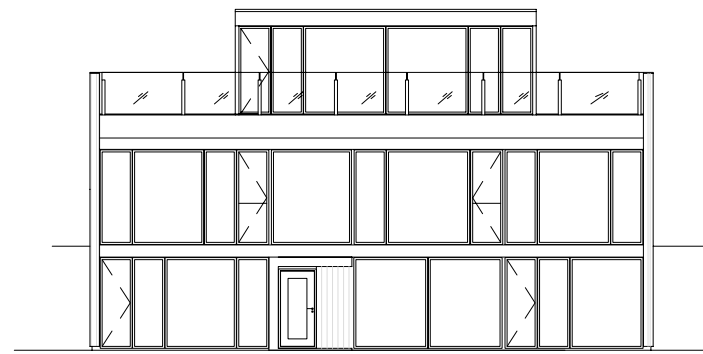

fasad B

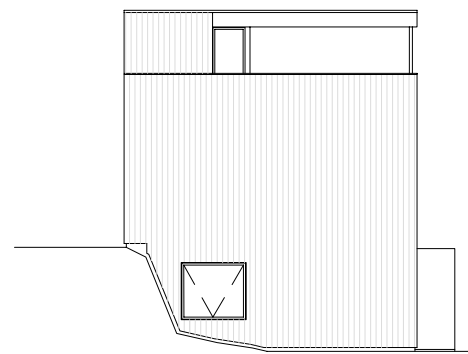

fasad C

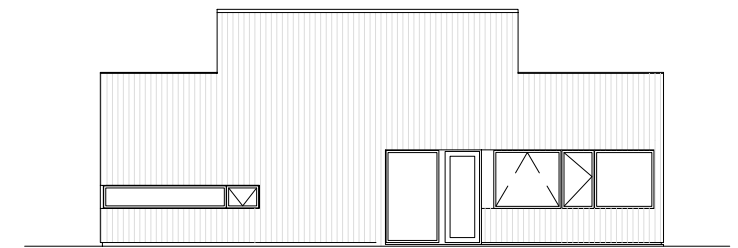

fasad D

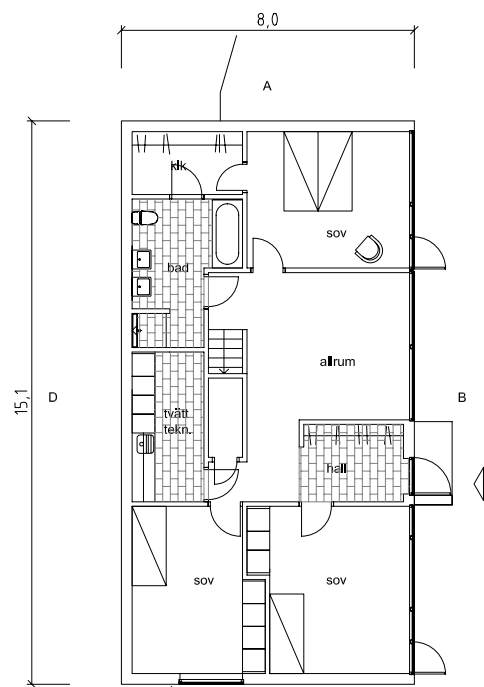

suterängplan

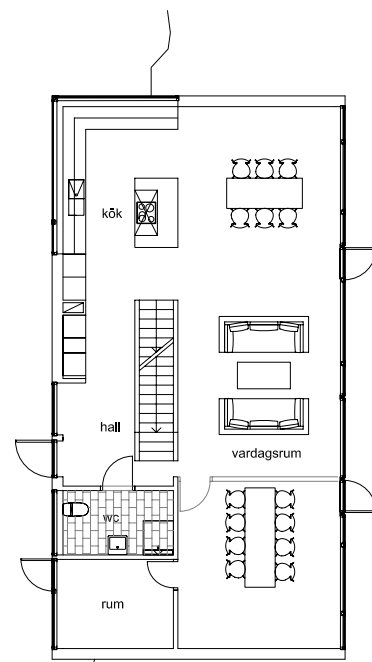

övre plan

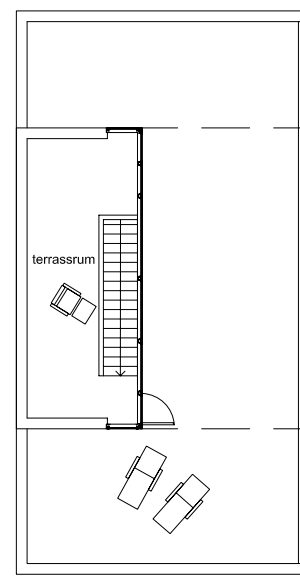

terrassplan

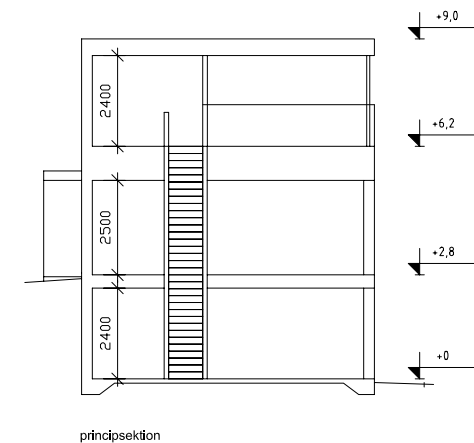

principsektion

Entrén med tak anpassas till suterrängplan eller övre plan.
Vägg i vardagsrum i val.



ARKITEKTHUS

Gert Wingårdh

HUS: AH#062
TYP: Suterräng med takterrass
BYA: 121 kvm
BOA: 210S+22 kvm

SKALA: 1:200 A3
DATUM: 2009

Med reservation för eventuella ändringar